

RADIORICEVITORE A TRANSISTOR RAYMOND RG 2041

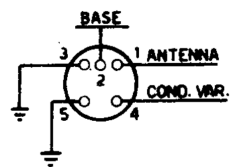

L 852
ANT. EST. OM

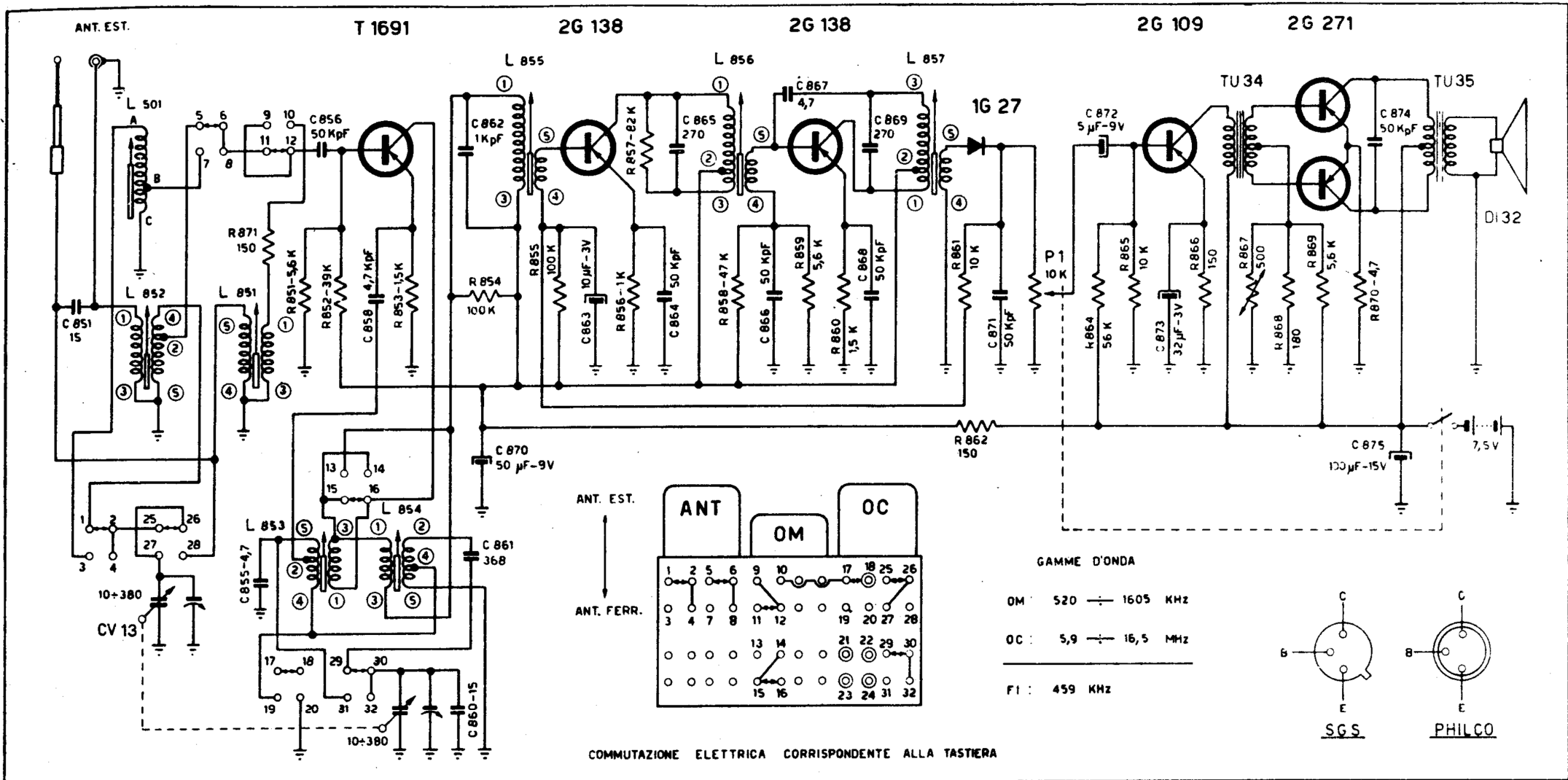
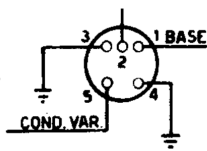

L 851
ANT. OC

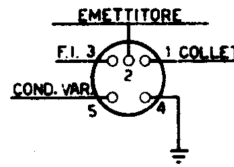

L 853
OSC. OC

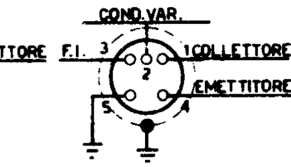

L 854
OSC. OM

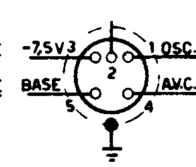

L 855
I F. I.

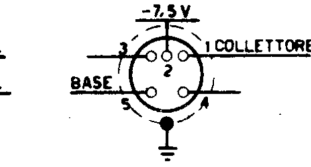

L 856
II F. I.

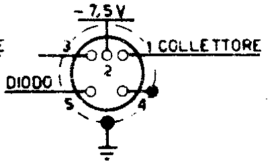

L 857
III F. I.